

**ModBlox**

# **PRODUCT INFORMATION / DATA SHEET**



**ModBlox – a modular revolution for your garden space!**

**[www.ModBlox.co.uk](http://www.ModBlox.co.uk)**

# PRODUCT OVERVIEW

Looking to build your own unique pergola? Look no further than ModBlox!

ModBlox is the ultimate DIY Modular Pergola System that offers kits or simply the hardware allowing you to build and customize or create your own unique build.

At ModBlox we have made it our mission to source the best possible materials and manufacturing processes to ensure you receive something built using only the highest quality craftsmanship.

ModBlox is built to last from the initial design process we have always had the vision to offer the best components we possibly can and have used 2mm thick, high-quality steel covered in weather-resistant coatings to produce all our components.

With a simple approach to style and design, the ModBlox system has endless possibilities you can customize your build to fit any space or budget.

With a focus on modularity, the ModBlox system allows for total customization. Let your imagination run wild as you design your perfect pergola, or choose one of our many standard designs. Furthermore, this system also allows you the option to add on or replace damaged timber instead of replacing the entire system.

To make ModBlox not only simple to use, we have tried to make sure that all our designs can be assembled by almost anyone with absolutely zero building experience.

Experience hassle-free construction in under 60 minutes, with no special tools required, meaning you can spend less time building and more time enjoying your new garden space.

Get ready to transform your outdoor space with ModBlox!

## ADVANTAGES



### Easy to Use

The simple modular construction method makes installing ModBlox a breeze. Simply slot your timber into the brackets and screw to fasten in place.



### Weather Resistant

Made using advanced weather coating technology to withstand extreme weather conditions. Featuring excellent colour retention properties in prolonged sunlight.



### Modular

ModBlox brackets can be configured in an infinite number of ways to create one-of-a-kind structures to your exact requirements.



### Durable

ModBlox components are built to last, using 14 gauge (2mm) galvanised steel. Our coated steel components have the ability to withstand high winds and heavy rainfall.

# GENERAL INFORMATION

**IMPORTANT** – Before undertaking any work, first take measurements of your planned install location so you can work out before you begin the build if you are going to have adequate space not only for the structure, but around it (if appropriate) for access.

Assembling your ModBlox pergola is fun and easy, even for novices with little or no building experience. Assembly with a friend can be done in as little as an hour (longer if your pergola includes roof rafters and/or a privacy wall). You won't need any speciality tools, either... just a drill, tape measure, level, ladder and saw (if required).

Our ModBlox pergola kits include everything you'll need to assemble your own beautiful garden pergola except the Post Mix / Ground Fixings (sold separately).

## SAFETY INFORMATION

- Do not leave your pergola unattended before installation is complete and the pergola is secured to the ground.
- Follow instructions precisely to avoid injury to yourself or others.
- Avoid scratching or bending the ModBlox pergola brackets to protect against damaging the coating which can lead to potential rusting.
- Safety glasses and safety gloves are encouraged during installation.
- Avoid installing your ModBlox pergola during inclement weather including rain, snow or windy conditions.
- In the event that you have pieces missing, please contact us at [hello@ModBlox.com](mailto:hello@ModBlox.com)

## RECOMMENDED TOOLS



Wear protective gloves, glasses and ear protectors where appropriate.

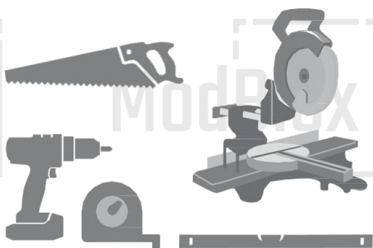

Hand Saw / Table Saw, Drill driver, Tape Measure, Spirit Level

# FAQ's

Please read the following FAQs for more information regarding ModBlox Pergolas. If you have questions that you can't find answers to, do not hesitate to contact us, we're more than happy to help!

## **What type of timber should I use when building my pergola?**

All our kits come supplied with premium grade, slow grown, pressure treated German whitewood which has been kiln dried to improve stability and straightness.

All our timber supplied in kits has a smoothed finish and eased edges, this timber is ready for staining or painting. This timber has been graded as premium as it has fewer, smaller visible knots on show and a straighter grain. The pressure treating process also makes it more resilient to weathering and insect infestation.

If you are buying the components as a standalone product (i.e. not one of our pre designed kits) you can in theory use any dry, straight timber of the correct dimensions, however some types of wood may just require a little more maintenance than the aforementioned whitewood we recommend.

## **What size timber should I use when building my pergola?**

All of our ModBlox Pergola kits come supplied with 92mm x 92mm Posts / Beams and our brackets are built specifically for this size.

## **What is included with my purchase of a pergola kit?**

- When ordering a pergola kit from us, your order will include the following:
- All required timber posts / beams
- All pergola brackets\*
- Self-tapping wood screws and caps for securing the wooden posts into the brackets

\*IMPORTANT NOTE: Depending on the pergola kit you order, it may or may not include a roof, privacy wall(s), side railing(s) or corner support brackets. If you purchase a base kit, you will need to add these optional upgrades separately.

## **What is NOT included with my purchase of a pergola kit?**

*Anchoring Hardware / PostMix*

While our pergola kits do include screws for securing your wood posts into the brackets, they do not include anchoring hardware for securing the base brackets into a secure base (i.e. cement pad, decking, patios, etc.) This is because the anchoring hardware you need will vary based on what type of material you're going into.

# FAQ's

## How wide can I make my pergola?

ModBlox Pergolas are modular, which means you can make your pergola as wide or as deep as you need it to be! But for each 'section' of your pergola, it is recommended that the beam be no longer than 12 feet. If you would like your pergolas overall width or depth to be greater than 12 feet, you'll just need to add on another section.

## What is the recommended height of a pergola?

Our recommendation for the height of your upright posts is 2.4 metres / 8 feet, this is what is included in all our pre designed kits. Pergola posts should never be taller than 10 feet.

For any posts longer than 8 feet, we strongly recommend using some form of additional supports / corner support brackets to add to stability and rigidity.

## How many people do I need to assemble my pergola?

For most builds we recommend having 2 people, however, for bigger jobs, it may be useful to have as many as 4 people there to help. We recommend that you check out the specific instructions for your exact kit to see what is involved with assembling your ModBlox Pergola.

## Why do you not need a screw for each hole on the brackets?

All of our brackets require only 2 screws per side (every set of eight holes).

As shown in the diagram to the right we recommend using the holes on the inside of your frame and the underside of the beams to keep the fixings as hidden as possible.

The other holes are designed to be left open for future accessories such as sunshades which would need to take advantage of these additional holes.

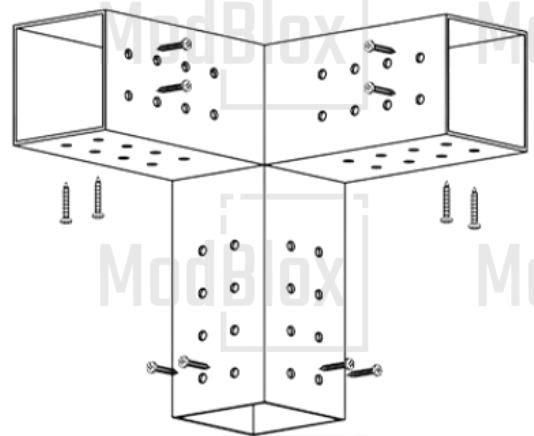

## What are the fixing recommended / supplied with my kit?

With all of our pre designed kits we supply 40mm fixing screws which feature a neoprene bonded washer and these are what we recommend for any custom self build to provide a solid and secure connection.

We also supply colour matching caps .

The sharp gash point ensures fast start. No pre-drilling, simply drive in with an 8mm (5/16") hexagon adapter.



# FAQ's

## How do I secure the pergola to the ground?

Due to the fact that there are so many different surface types that a pergola could be mounted or anchored to we offer three fixing options with all our pre designed kits.

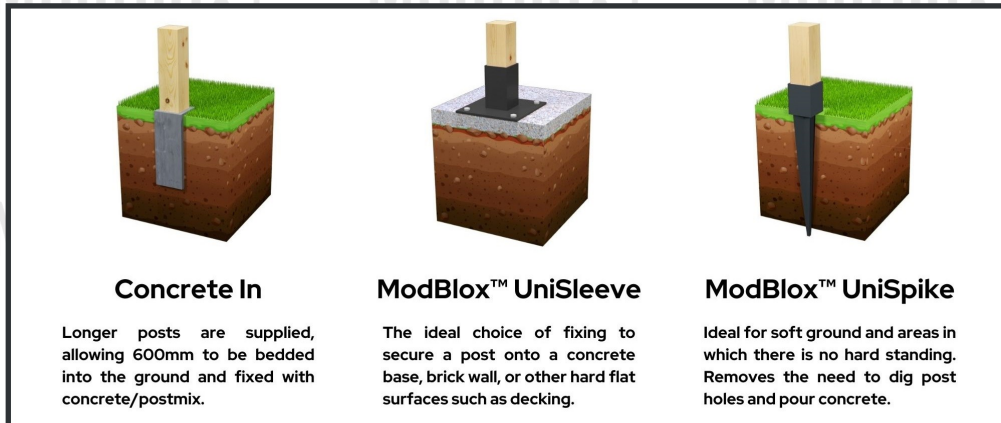

## What are ModBlox brackets made of?

No matter the bracket, the following specs apply:

- 14-gauge steel (approx. 2mm thick)
- Laser-cut, bent and welded
- Advanced weather coating technology to withstand extreme weather conditions
- Pre-drilled holes for securing wooden posts to the brackets

## I need help placing an order... can you help?

Most definitely! We realize that piecing together the perfect pergola can be a complicated process for a beginner, that's why we have a super-efficient sales team standing by to help with recommendations and to address any queries you may have.

You can email us at [hello@ModBlox.com](mailto:hello@ModBlox.com).

## Are Modblox Pergolas covered by a warranty?

All of our metal brackets and accessories are covered by a 10 year limited warranty. This means that they are warranted against manufacturer's defects upon arrival and that they are warranted to be effective and adequate for their design purposes for a period of no less than 10 years.

*This information is provided in good faith and there are no guarantees; while the information in this document has been verified to the best of our abilities, we cannot guarantee that there are no mistakes or errors. All information posted is merely for educational and informational purposes. It is not intended as a substitute for professional advice. Should you decide to act upon any information on this document, you do so at your own risk.*

# ModBlox

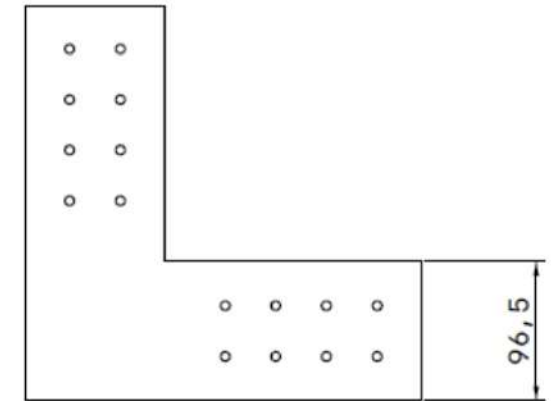
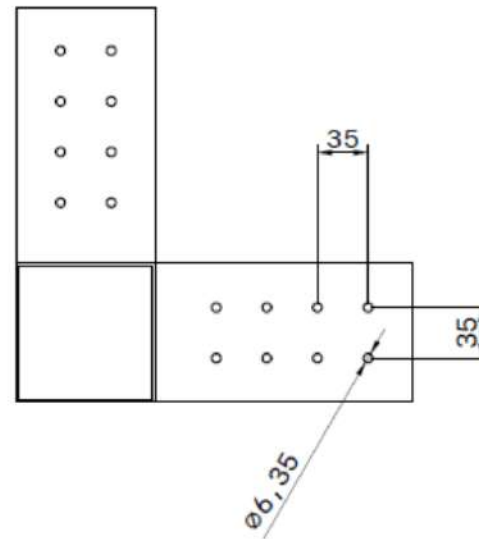
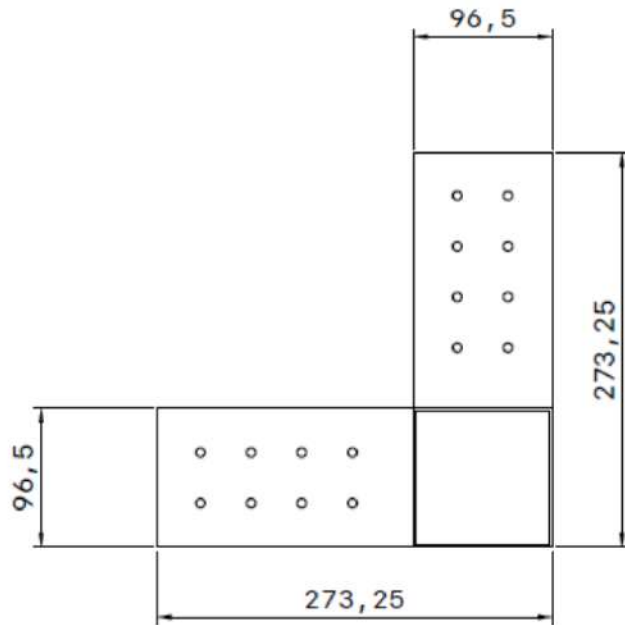

Arm Opening (Interior):	3.61" x 3.61"	92mm x 92mm
Arm Opening (Exterior):	3.75" x 3.75"	95mm x 95mm
Insertable Length:	7"	175mm
Fastening Holes:	0.25"	6.35mm
Steel Thickness:		2mm
Colour:	Powder Coated RAL7021 Black Grey	

## ModBlox™ TriSleeve

Tech\_Specs\_Drawing\_V1 21\_05\_24

# ModBlox

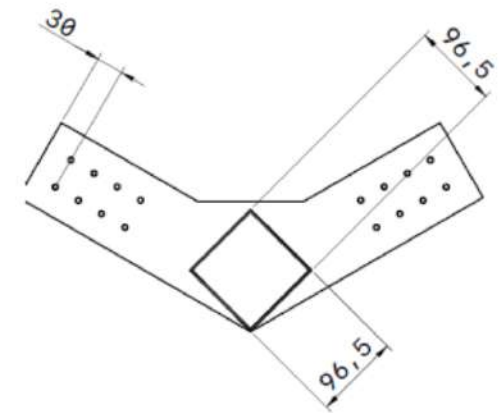
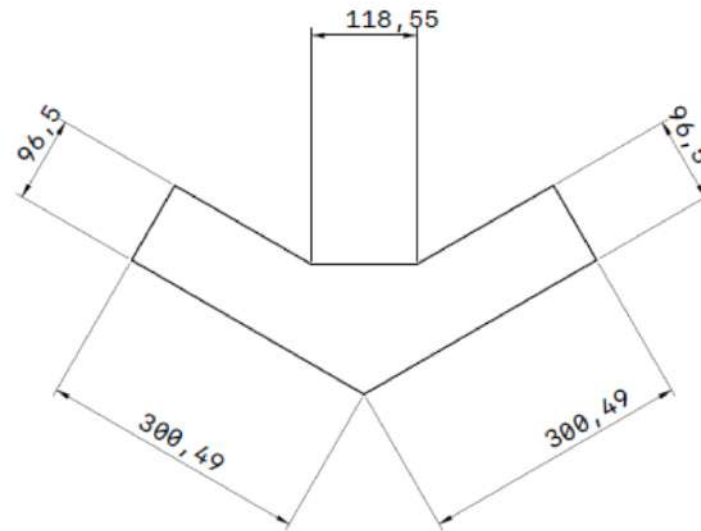
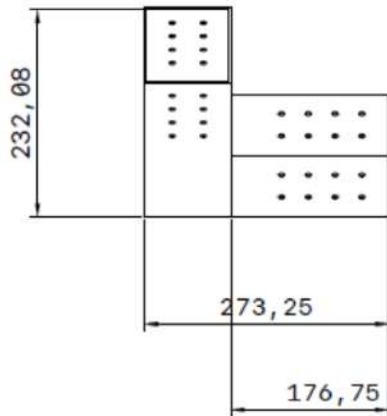
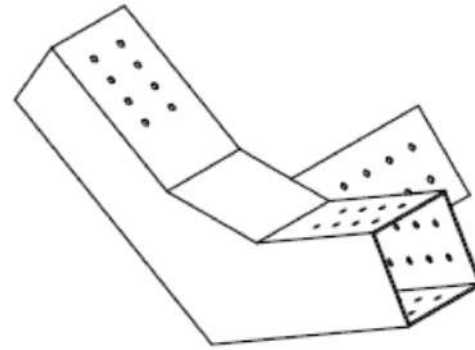

Arm Opening (Interior):	3.61" x 3.61"	92mm x 92mm
Arm Opening (Exterior):	3.75" x 3.75"	95mm x 95mm
Insertable Length:	7"	175mm
Fastening Holes:	0.25"	6.35mm
Steel Thickness:		2mm
Colour:	Powder Coated RAL7021 Black Grey	

## ModBlox™ Apex TriSleeve

Tech\_Specs\_Drawing\_V1 21\_05\_24



# ModBlox

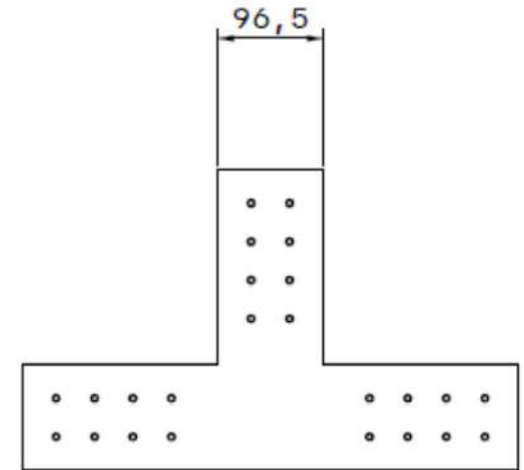
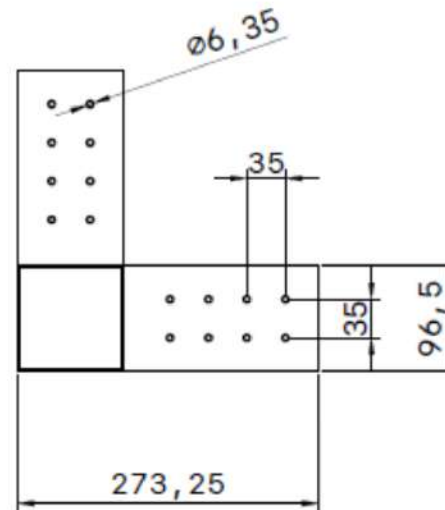
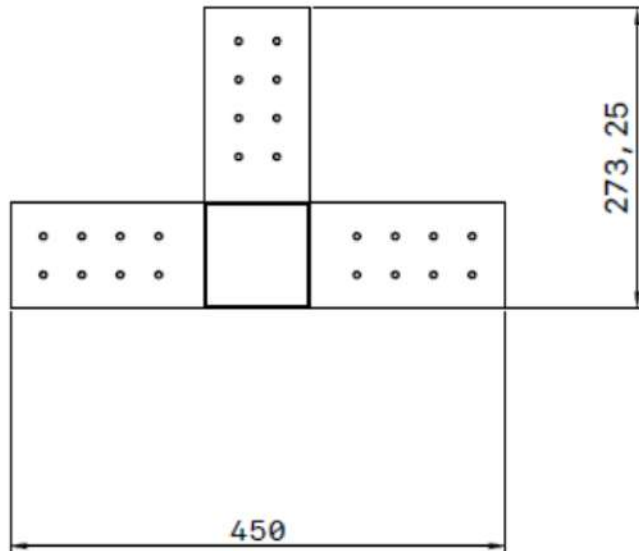
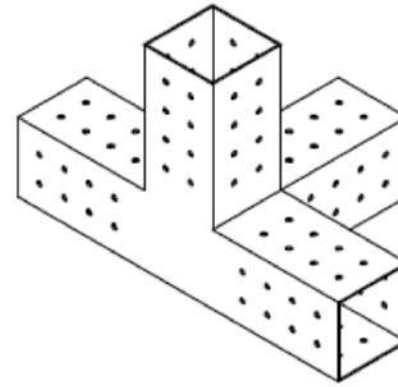
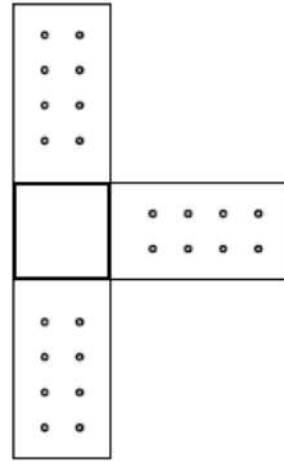

Arm Opening (Interior):	3.61" x 3.61"	92mm x 92mm
Arm Opening (Exterior):	3.75" x 3.75"	95mm x 95mm
Insertable Length:	7"	175mm
Fastening Holes:	0.25"	6.35mm
Steel Thickness:		2mm
Colour:	Powder Coated RAL7021 Black Grey	

## ModBlox™ QuadSleeve

Tech\_Specs\_Drawing\_V1 21\_05\_24

# ModBlox

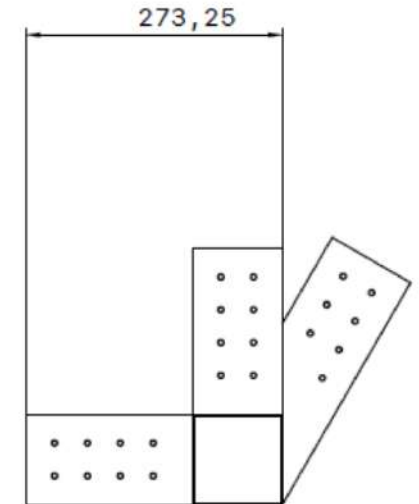
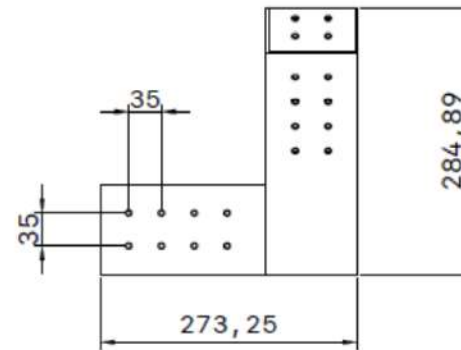
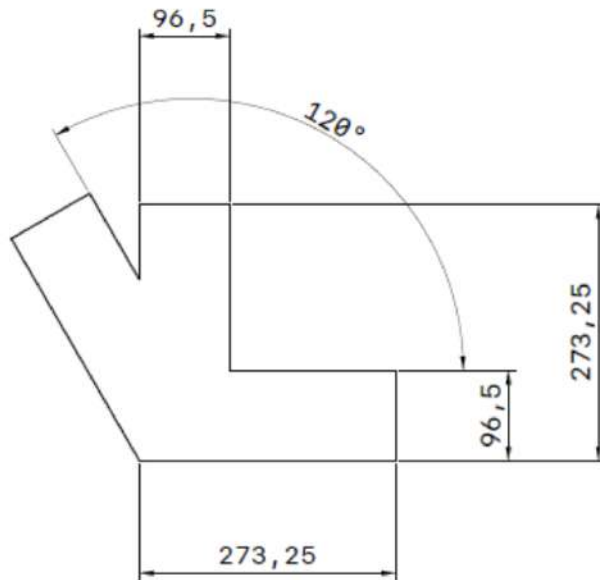
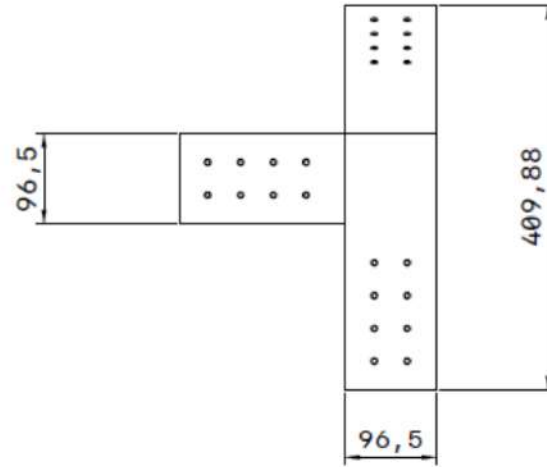

Arm Opening (Interior):	3.61" x 3.61"	92mm x 92mm
Arm Opening (Exterior):	3.75" x 3.75"	95mm x 95mm
Insertable Length:	7"	175mm
Fastening Holes:	0.25"	6.35mm
Steel Thickness:		2mm
Colour:	Powder Coated RAL7021 Black Grey	

## ModBlox™ Corner Angled QuadSleeve (Right/Left)

Tech\_Specs\_Drawing\_V1 21\_05\_24

# ModBlox

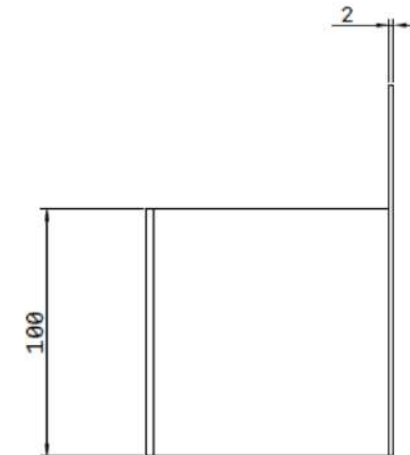
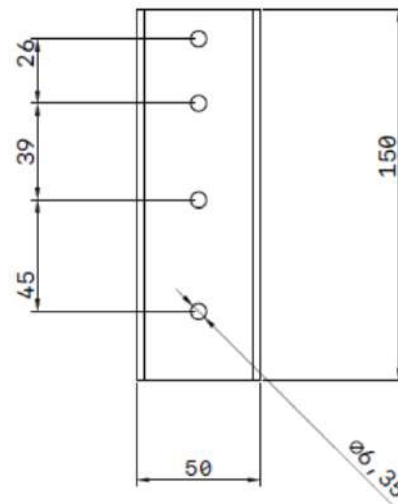
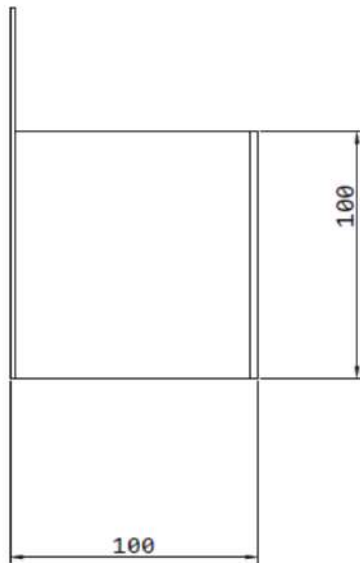
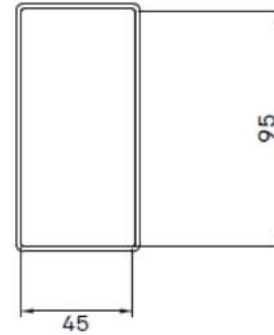
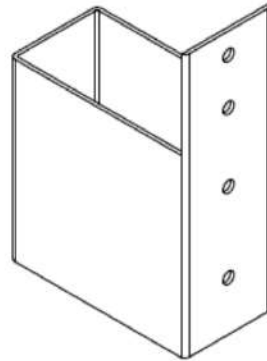

Arm Opening (Interior):	3.75" x 1.77"	95mm x 45mm
Arm Opening (Exterior):	4" x 2"	100mm x 50mm
Insertable Length:	4"	100mm
Fastening Holes:	0.25"	6.35mm
Steel Thickness:		2mm
Colour:	Powder Coated RAL7021 Black Grey	

## ModBlox™ Rafter Sleeve

Tech\_Specs\_Drawing\_V1 21\_05\_24

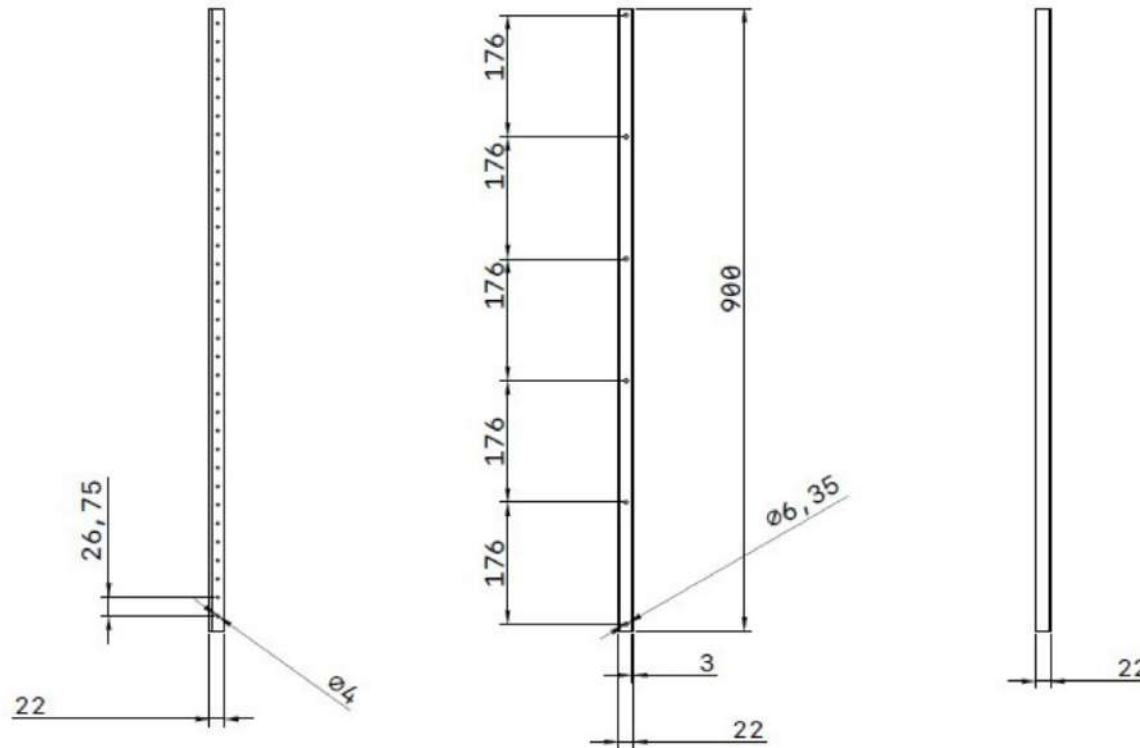
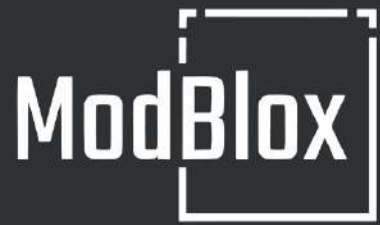

Inner Fastening Holes:	0.25"	6.35mm
Side Fastening Holes:	0.1575"	4mm
Steel Thickness:		2mm
Colour:	Powder Coated RAL7021 Black Grey	

# ModBlox™ U Channel 22mm

Tech\_Specs\_Drawing\_V1 21\_05\_24

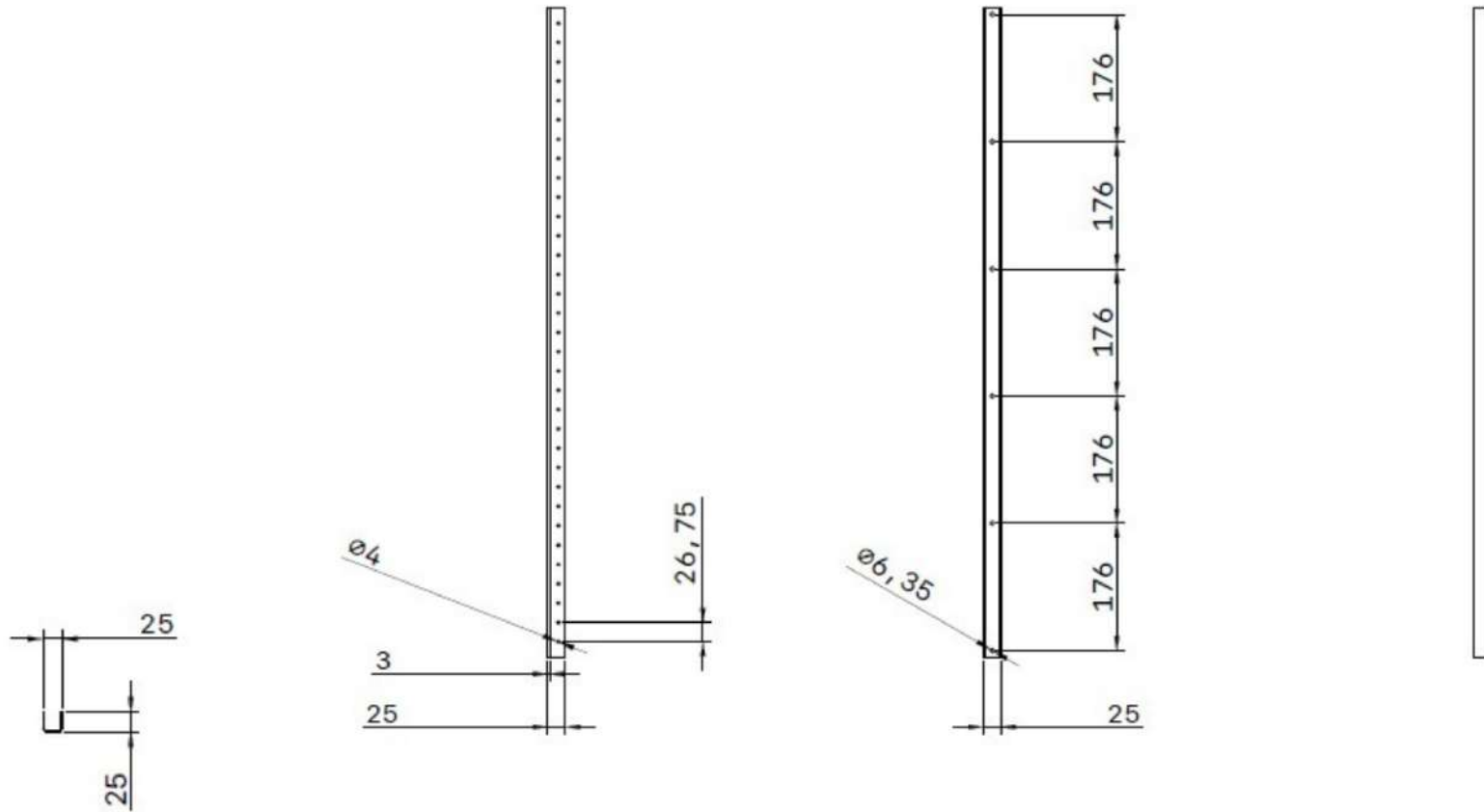
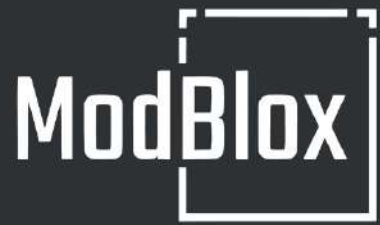

Inner Fastening Holes:	0.25"	6.35mm
Side Fastening Holes:	0.1575"	4mm
Steel Thickness:		2mm
Colour:	Powder Coated RAL7021 Black Grey	

# ModBlox™ U Channel 25mm